

Date:

Type:

Project:



EPO PENDANT

This 4-sided pendant has soft, smooth corners with light source at the inner part of the luminaire emitting directly downwards. Give it a funky twist with custom color, vinyl, or wood grain finishing.

Name	Size	Lamping	Lumens*	Color Temp	Electrical			Mounting
EPO	24	35W LED	3300	3000K	UNV	120-277V	4AC48	four 48" aircraft cables with individual square canopies
	36	54W LED	5128	3500K	HLV	347-480V	4AC-SPD	four aircraft cables & spider mount connecting to hub
	48	74W LED	6958	4000K			4AC-TR	four aircraft cables converge to single square canopy
			5000K				4AC-SPD-P	combination of 4 aircraft cables, spider mount, & pendant stem

Lens		Light Pattern		Options			Finishes	
OAL	Opal acrylic lens (Std)	TY5	Type V distribution (Std)	DM	0-10V Dimming	BL	Black	
				RB	Remote driver	BZ	Bronze	
				2CC	2 circuit wiring	WH	White	
				VYN	Vinyl or wood grain finish, contact factory for options	SG	Silver Grey	
				EM	Emergency battery			
				RGBW	Programmable color changing LEDs	BA4	Brushed Aluminum #4	
						CC	Custom Color	

Contact factory for various finishes.
[See finishes info on website](#)

*Lumens are based on Maximum Wattage, Type V Distribution, and 5000K CCT
 *Specific IES Files available upon request
 Std – Standard Offering

EPO- _____

Customization Notes:

→ Info on this spec sheet will change without notice as product development is an ongoing process.

Dimensions & Mounting (drawings are not to scale; all dimensions in inches)

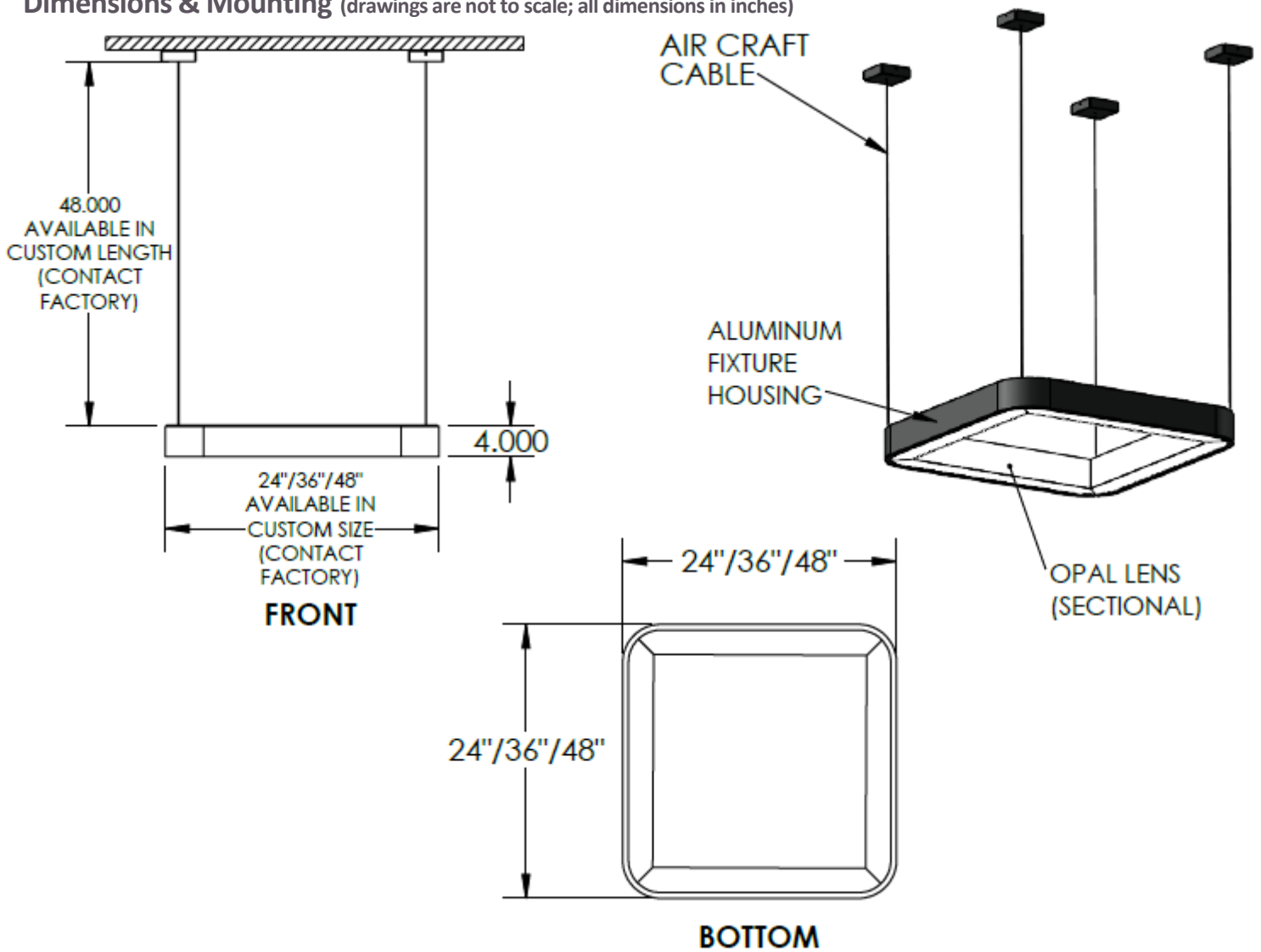

MOUNTING OPTIONS:

